

ICOM

INSTRUCTION MANUAL

PMR446 TRANSCEIVER

IC-F27SR



Icom Inc.

PREFACE

READ ALL INSTRUCTIONS carefully and completely before using the transceiver.

SAVE THIS INSTRUCTION MANUAL— This instruction manual contains important operating instructions for the IC-F27SR PMR446 TRANSCEIVER.

This instruction manual includes some functions which are usable only when they are preprogrammed by your dealer. Ask your dealer for details.

EXPLICIT DEFINITIONS

WORD	DEFINITION
⚠ DANGER!	Personal death, serious injury or an explosion may occur.
⚠ WARNING!	Personal injury, fire hazard or electric shock may occur.
CAUTION	Equipment damage may occur.
NOTE	If disregarded, inconvenience only. No risk of personal injury, fire or electric shock.

Icom, Icom Inc. and Icom logo are registered trademarks of Icom Incorporated (Japan) in Japan, the United States, the United Kingdom, Germany, France, Spain, Russia, Australia, New Zealand, and/or other countries.

ABOUT CE AND DOC



Hereby, Icom Inc. declares that the versions of IC-F27SR which have the “CE” symbol on the product, comply with the essential requirements of the Radio Equipment Directive, 2014/53/EU, and the restriction of the use of certain hazardous

substances in electrical and electronic equipment Directive, 2011/65/EU. The full text of the EU declaration of conformity is available at the following internet address:

<https://www.icomjapan.com/support/>

DISPOSAL



The crossed-out wheeled-bin symbol on your product, literature, or packaging reminds you that in the European Union, all electrical and electronic products, batteries, and accumulators (rechargeable batteries) must be taken to designated collection locations at the end of their working life. Do not dispose of these products as unsorted municipal

waste. Dispose of them according to the laws in your area.

Icom is not responsible for the destruction, damage to, or performance of any Icom or non-Icom equipment, if the malfunction is because of:

- Force majeure, including, but not limited to, fires, earthquakes, storms, floods, lightning, other natural disasters, disturbances, riots, war, or radioactive contamination.
- The use of Icom transceivers with any equipment that is not manufactured or approved by Icom.

PRECAUTIONS

⚠ **DANGER! NEVER** short the terminals of the battery pack.

⚠ **DANGER!** Use and charge only specified Icom battery packs with Icom radios or Icom chargers. Only Icom battery packs are tested and approved for use with Icom radios or charged with Icom chargers. Using third-party or counterfeit battery packs or chargers may cause smoke, fire, or cause the battery to burst.

⚠ **WARNING! NEVER** hold the transceiver so that the antenna is very close to, or touching exposed parts of the body, especially the face or eyes, while transmitting. The transceiver will perform best if the microphone is 5 to 10 cm away from the lips and the transceiver is vertical.

⚠ **WARNING! NEVER** operate the transceiver with a headset or other audio accessories at high volume levels. Hearing experts advise against continuous high volume operation. If you experience a ringing in your ears, reduce the volume level or discontinue use.

⚠ **WARNING! NEVER** operate the transceiver while driving a vehicle. Safe driving requires your full attention—anything less may result in an accident.

CAUTION: NEVER connect the transceiver to a power source other than the specified battery pack/case. Such a connection will ruin the transceiver.

CAUTION: MAKE SURE the battery pack is securely attached to the transceiver, and that the battery pack is dry before attachment. Exposing the inside of the transceiver to water will result in serious damage to the transceiver.

NEVER place the transceiver in an insecure place to avoid inadvertent use by unauthorized persons.

DO NOT push the PTT when not actually desiring to transmit.

DO NOT use or place the transceiver in direct sunlight or in areas with temperatures below -25°C or above $+55^{\circ}\text{C}$.

The basic operations, transmission and reception of the transceiver, are guaranteed within the specified operating temperature range.

DO NOT modify the transceiver. The transceiver warranty does not cover any problems caused by unauthorized modification.

DO NOT use harsh solvents such as benzine or alcohol when cleaning, as they will damage the transceiver surfaces.

BE CAREFUL! The transceiver will become hot when operating it continuously for long periods of time.

KEEP the transceiver away from heavy rain, and never immerse it in water. The transceiver meets IP54* requirements for dust-protection and splash resistance. However, once the transceiver has been dropped, dust-protection and splash resistance cannot be guaranteed because of possible damage to the transceiver's case or the waterproof seal.

* Only when the battery pack/case and jack cover are attached.

MAKE SURE to turn the transceiver power OFF before connecting the supplied/optional equipment.

TABLE OF CONTENTS

PREFACE	i
EXPLICIT DEFINITIONS	i
ABOUT CE AND DOC	ii
DISPOSAL	ii
PRECAUTIONS	iii
1 ACCESSORIES	1
■ Supplied accessories	1
■ Accessory attachments	2
◇ Belt clip	2
◇ Battery pack/case	3
◇ Jack cover	4
2 PANEL DESCRIPTION	5
■ Front, top and side panels	5
■ Programmable key functions	7
■ LED indicator	9
3 OPERATION	10
■ Turning ON the power	10
◇ Battery type selection	10
■ Channel selection	11
■ Receiving and transmitting	12
◇ Preprogrammed frequency and CTCSS tone list (Default) ..	13
◇ Transmitting notes	14
■ Setting the microphone gain	15
■ Setting the squelch level	16
■ Priority A channel selection	17
■ Auto scan function	17
■ Power save function	17

4 BATTERY CHARGING	18
■ Caution (for the BP-299 Li-ion battery)	18
◇ Battery caution	18
◇ Charging caution	21
■ Battery chargers.....	22
◇ Using the BC-240 to rapid charge the BP-299	22
◇ About the BC-240.....	23
◇ Using the BC-214N to rapid charge the BP-299.....	24
5 BATTERY CASE	26
■ Optional BP-263 BATTERY CASE	26
6 OPTIONS	27
◇ BATTERY PACK/CASE.....	27
◇ CHARGERS	27
◇ DC POWER CABLES.....	28
◇ BELT CLIPS.....	28
◇ OTHER OPTIONS.....	29
■ VOX function	30
◇ Optional unit connection.....	30
◇ Turning the VOX function ON or OFF	31
◇ Setting the VOX gain	32
7 SPECIFICATIONS	33
◇ General.....	33
◇ Dimensions.....	33
◇ Transmitter.....	34
◇ Receiver	34
INDEX	35

1 ACCESSORIES

■ Supplied accessories

The following accessories are supplied with the transceiver.

Battery pack*

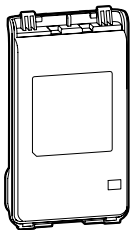

Battery charger*

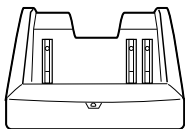

AC adapter*

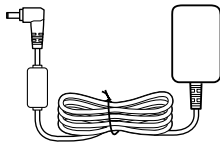

Belt clip



Jack cover
(with screws)

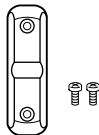

* Not supplied, or the shape is different, depending on the version.

■ Accessory attachments

◇ Belt clip

To attach the belt clip:

- Slide the belt clip in the direction of the arrow until it locks in place, and makes a 'click' sound.

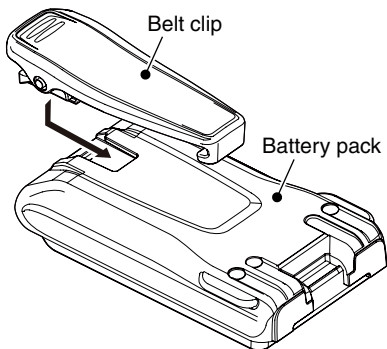

To detach the belt clip:

- ① Remove the battery pack from the transceiver, if it is attached. (p. 3)
- ② Lift the tab up (①), and slide the belt clip in the direction of the arrow (②).

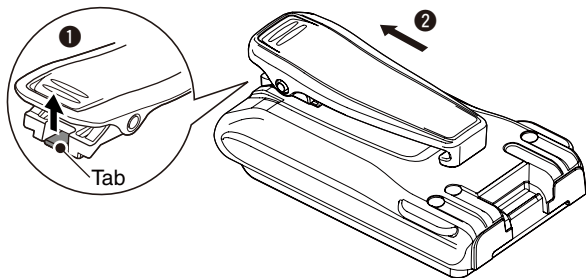

1 ACCESSORIES

■ Supplied accessories (continued)

◇ **Battery pack/case**

To attach the battery pack/case:

- ① Fit the battery pack/case in the direction of the arrow, then close.
- ② Hook the latch until it makes a 'click' sound.

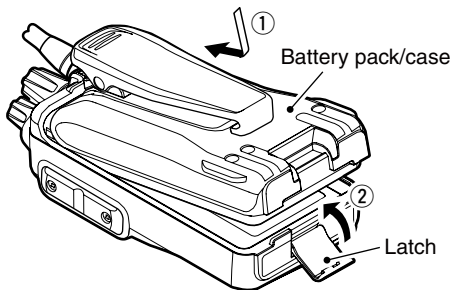

To remove the battery pack/case:

Unhook the latch (①), and lift up the battery pack/case in the direction of the arrow (②).

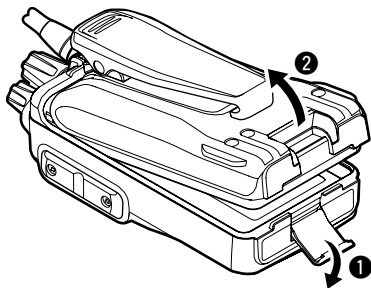

Be careful! The latch is tightly locked, so use caution when releasing it. **DO NOT** use your finger nail. Use the edge of a coin or screwdriver tip to carefully release it.

NEVER remove or attach the battery pack/case when the transceiver is wet or soiled. This may result in water or dust getting into the transceiver, battery pack/case, and may result in them being damaged.

NOTE: Keep the battery terminals clean. It's a good idea to regularly clean them.

◇ Jack cover

Attach the jack cover when optional equipment is not used.

To attach the jack cover:

- ① Attach the jack cover to the [SP MIC] jack.
- ② Tighten the screws.

To detach the jack cover:

- ① Remove the screws with a Phillips screwdriver.
- ② Detach the jack cover to connect optional equipment.

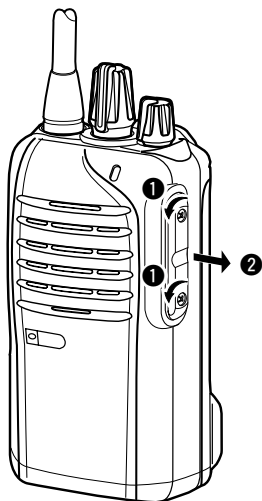
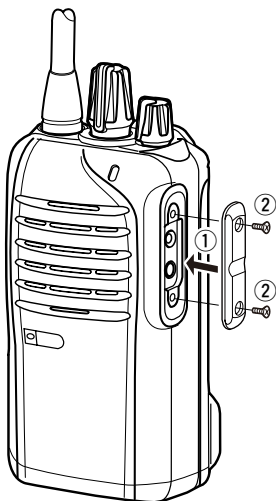

2 PANEL DESCRIPTION

■ Front, top and side panels

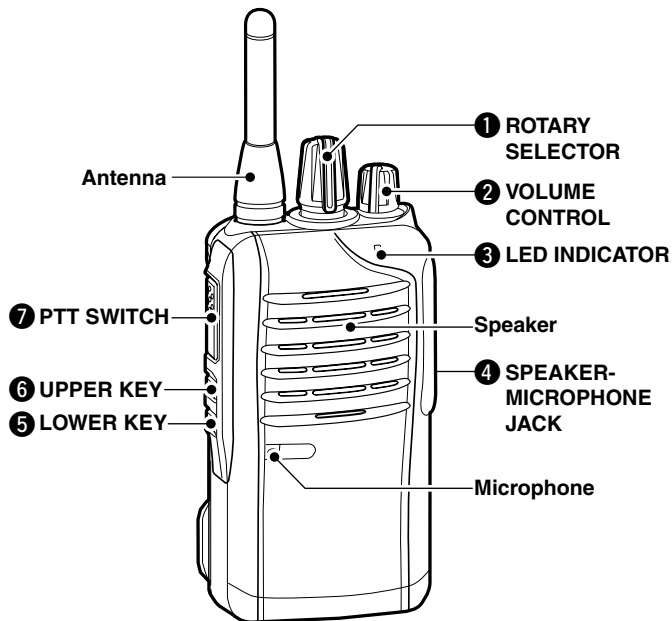

1 ROTARY SELECTOR

Rotate to select the preprogrammed memory channels.

2 VOLUME CONTROL [VOL]

Rotate to turn the power ON/OFF, and adjust the audio level.

3 LED INDICATOR (p. 9)

- ➔ Lights red* while transmitting.
*When the optional battery case is attached, the LED indicator lights orange.
- ➔ Lights green while receiving a signal, or when the squelch is open.

4 SPEAKER-MICROPHONE JACK [SP MIC]

Connect the optional speaker-microphone or plug adapter cable.



Jack cover

NOTE: Attach the jack cover when optional equipment is not used. (p. 4)

5 LOWER KEY [Lower]**6 UPPER KEY [Upper]**

The desired function can be assigned by your dealer. (p. 7)

7 PTT SWITCH [PTT]

Hold down to transmit; release to receive.

■ Programmable key functions

Various functions can be assigned to the [Upper] and [Lower] programmable function keys.

If [Upper] or [Lower] is preprogrammed, push to activate whichever function is set.

Consult your Icom dealer for details concerning which functions are programmed into the key.

SCAN A

- Push to start or cancel the scanning operation.
- When the Power ON scan function is turned ON, push to pause the scanning. The paused scan resumes after the specified time period has passed.

SCAN B

Push to start or cancel scanning.

If the scan pauses for any reason, except being cancelled by this key, it will resume after a specified time period has passed.

PRIORITY A CHANNEL, PRIORITY B CHANNEL

Push to select the Priority A or Priority B channel.

PRIORITY A CHANNEL (REWRITE), PRIORITY B CHANNEL (REWRITE)

- Push to select the Priority A or Priority B channel.
- Hold down [PRIO A (Rewrite)] or [PRIO B (Rewrite)] for 1 second to assign the operating channel to Priority A or Priority B channel, respectively.

MEMORY CHANNEL 1, MEMORY CHANNEL 2, MEMORY CHANNEL 3, MEMORY CHANNEL 4

Push to select memory channel 1, 2, 3 or 4, if programmed. Consult your dealer for details.

MONITOR

- Hold down for 1 second to temporarily release the CTCSS*¹ (or DTCS*²) squelch mute.
- Push to activate the CTCSS*¹ (or DTCS*²) squelch mute.
- Holding down [MONI] opens any squelch and deactivates any mute.

*¹ Continuous Tone Coded Squelch System

*² Digital Tone Coded Squelch

LOCK

Hold down for 1 second to electronically lock all programmable keys except [MONI], [LOCK], [SURVEILLANCE] and [SIREN].

SURVEILLANCE

- Push to turn the Surveillance function OFF.
- Hold down for 1 second to turn the Surveillance function ON.
 - When this function is turned ON, the beep is not heard and the LED does not light, even if a signal is received, or you push a key.

SIREN

Hold down for 1 second to emit a siren sound.

You can use this function for situations other than an emergency alert, such as a security alarm for example.

The transceiver will emit the siren sound until you turn OFF the power.

■ LED indicator

The LED indicator indicates the status of various parameters of the transceiver, as follows;
(Ref.; R=Red, G=Green, O=Orange)



- TX: Lights Red while transmitting a signal.



- RX: Lights Green while receiving a signal.

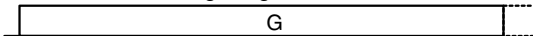

- Fast/Slow scan: Blinks when the Fast/Slow scan is activated.

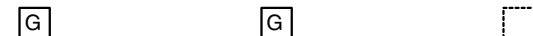

- Low Battery 1: You should charge the battery. (blinks slowly)



- Low Battery 2: You must charge the battery. (blinks fast)

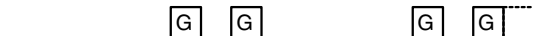

- TX low Battery 1: Low Battery was detected during transmit.



- TX low Battery 2: Very Low Battery was detected during transmit.



- Channel Error: A non-programmed channel is selected.



- * Lights (or blinks) orange when the optional battery case is attached.

■ Turning ON the power

▨ Prior to using the transceiver for the first time, the battery pack must be fully charged for optimum life and operation. (p. 18)

➔ Rotate [VOL] to turn ON the power.



◇ Battery type selection

The battery type must be selected according to the battery pack or case when it is changed, but only the first time it is used.

Check the battery type before you begin the selection procedure.

One to three beep(s) sound in sequence, so you must repeat the steps until the number of beeps matches your battery type.

For example, if your battery type is a Ni-MH battery pack, you must repeat the procedure until 3 beeps are heard.

① Set [ROTARY SELECTOR] to any channel other than Channel 16.

② Rotate [VOL] to turn OFF the transceiver power.

③ While holding down [PTT], rotate [VOL] to turn ON the power.

- You should hold [PTT] until the battery type confirmation beeps sound. (It takes approximately 5 seconds; while holding down [PTT], the count down beeps sound. After that, the confirmation beeps sound.)

- 1 beep sounds when the Li-ion battery is selected.
- 2 beeps sound when the battery case is selected.
- 3 beeps sound when the Ni-MH battery is selected.

④ After the beep sounds, release [PTT].

⑤ Repeat steps ② to ④ until you select the correct battery type.

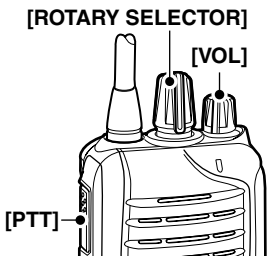

▨ **NOTE:** This operation may not be available, depending on the preprogramming. Ask your dealer for details.

■ Channel selection

Several types of channel selecting methods are available. They may differ, according to your system set up.

To select a desired operating channel, do one of the following:

- Rotate [ROTARY SELECTOR].
- Push one of memory channel keys, [MR-CH 1] to [MR-CH 4].

AUTOMATIC SCAN TYPE:

Selecting a channel is not necessary for this type. When turning the power ON, the transceiver automatically starts scanning. Scanning stops when a signal is received, and then the channel is set.

NOTE: If the Move to Priority A channel at Power ON function (p. 17) is turned ON, the transceiver does not start scanning at power ON, and the Priority A channel is automatically selected.

■ Receiving and transmitting

Receiving:

- ① Rotate [VOL] to turn ON the power.
- ② Rotate [ROTARY SELECTOR], or push one of the memory channel keys, [MR-CH 1] to [MR-CH 4], to select a channel.
- ③ When receiving a call, adjust the audio output to a comfortable listening level.
 - When the received signal contains the same CTCSS tone or DTCS code, the LED indicator lights green.
 - If no audio is heard, hold down [MONI] while adjusting the audio output level. Release to receive.
- ④ The transceiver is now set to receive on the selected channel.

 **NOTE:** The transceiver may be equipped with CTCSS tone or DTCS code capability. The CTCSS tone squelch or DTCS squelch opens only when the received signal includes a matching tone or code. You can silently wait to receive calls from only stations using the same tone or code. The default settings for each channel are listed on the next page.

Transmitting:

Wait for the channel to become clear to avoid interfering.

- ① While holding down [PTT], speak into the microphone at a normal voice level.
- ② Release [PTT] to receive.

 **IMPORTANT:** To maximize the readability of your signal;

1. Pause briefly after pushing [PTT].
2. Hold the microphone 5 to 10 cm from your mouth, then speak into the microphone at a normal voice level.

3 OPERATION

■ Receiving and transmitting (continued)

◇ Preprogrammed frequency and CTCSS tone list (Default)

CH	Frequency (MHz)* ¹	Tone (Hz)* ²
1	446.006250	No setting
2	446.018750	No setting
3	446.031250	No setting
4	446.043750	107.2
5	446.056250	110.9
6	446.068750	114.8
7	446.081250	118.8
8	446.093750	123.0
9	446.006250	127.3
10	446.018750	131.8
11	446.031250	136.5
12	446.043750	141.3
13	446.056250	146.2
14	446.068750	151.4
15	446.081250	156.7
16	446.093750	159.8

*¹ The operating channel frequencies cannot be changed.

*² The DTCS codes or different CTCSS tone frequencies may be pre-programmed instead of the CTCSS tones as listed above. Ask your dealer for details.

◇ Transmitting notes

• Transmit inhibit function

The transceiver has several inhibit functions which restrict transmission under the following conditions:

- The channel is muted.
- The channel is busy.
- A signal with an un-matched CTCSS (or DTCS) tone is received.
- The selected channel is a 'receive only' channel.

• Time-out timer

The transceiver has a time-out timer function which prevents continuous, extend transmissions.

After continuously transmitting longer than the preprogrammed time period, the Time-out timer function activates, and stops further transmitting.

• Penalty timer

Once the time-out timer function activates, transmitting is further inhibited for a time period determined by the penalty timer.

■ Setting the microphone gain

Adjusts the microphone gain.

- ① Rotate [VOL] to turn OFF the transceiver power.
- ② Set [ROTARY SELECTOR] to any channel other than Channel 16.
- ③ While pushing and holding [Lower], rotate [VOL] to turn ON the power and enter the microphone gain adjustment mode.
- ④ Push [Upper] to increase, or push [Lower] to decrease the microphone gain.
 - The adjustable range is 1 (minimum) to 4 (maximum).
 - A beep sounds after pushing [Upper] or [Lower].
If the level is set on 1 or 4, a low tone error beep sounds.
Therefore, you can determine the current level setting by the type of beep that sounds.
- ⑤ Rotate [VOL] to turn OFF the power, then turn ON again to exit the microphone gain adjustment mode.

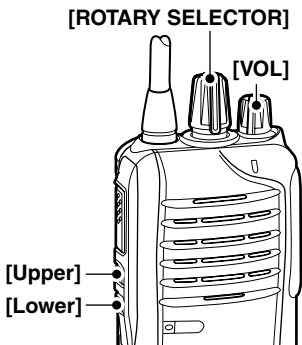

NOTE: This operation may not be available, depending on the preprogramming. Ask your dealer for details.

✓ INFORMATION:

When using the VOX function, we recommend setting the microphone gain to 3. However, you can adjust it to suit your operating environment (including your headset performance).

■ Setting the squelch level

The squelch circuit mutes the received audio signal, depending on the signal strength and the squelch setting.

- ① Rotate [VOL] to turn OFF the transceiver power.
- ② Set [ROTARY SELECTOR] to any channel other than Channel 16.
- ③ While pushing and holding [PTT] and [Lower], rotate [VOL] to turn ON the power and enter the squelch level adjustment mode.
- ④ Push [Upper] to increase the squelch level (tight squelch), or push [Lower] to decrease the squelch level (loose squelch).
 - The adjustable range is 0 (loose squelch) to 9 (tight squelch).
 - A beep sounds after pushing [Upper] or [Lower].
If the level is set on 0 or 9, an error beep sounds after pushing.
Therefore, you can determine the current level setting by the type of beep that sounds.
- ⑤ Rotate [VOL] to turn OFF the power, then turn ON again to exit the squelch level adjustment mode.

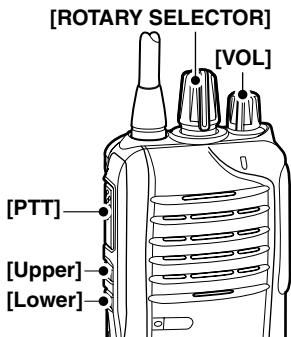

NOTE: This operation may not be available, depending on the preprogramming. Ask your dealer for details.

■ Priority A channel selection

Depending on the preprogramming, the Priority A channel is selected each time the transceiver power is turned ON.

■ Auto scan function

The Auto scan function sequentially scans from the selected channel. Scanning automatically searches for signals and makes it easier for you to find stations to contact or to just listen to.

- ① Set [ROTARY SELECTOR] to any channel that the Auto scan function is ON.
- ② Scan starts automatically.
 - The LED indicator slowly blinks green.
 - When receiving a signal, scan pauses until the signal disappears.

■ Power save function

The power save function reduces the current drain to conserve battery power.

- Depending on the preprogramming, the power save function is automatically turned ON when no operation is performed or no signal is received for the preprogrammed time period. Ask your dealer for details.

BATTERY CHARGING 4

■ Caution (for the BP-299 Li-ion BATTERY)

Misuse of Li-ion batteries may result in the following hazards: smoke, fire, or the battery may rupture. Misuse can also cause damage to the battery or degradation of battery performance.

⚠ **DANGER!** Use and charge only specified Icom battery packs with Icom radios or Icom chargers. Only Icom battery packs are tested and approved for use with Icom radios or charged with Icom chargers. Using third-party or counterfeit battery packs or chargers may cause smoke, fire, or cause the battery to burst.

◇ Battery caution

⚠ **DANGER! DO NOT** hammer or otherwise impact the battery. Do not use the battery if it has been severely impacted or dropped, or if the battery has been subjected to heavy pressure. Battery damage may not be visible on the outside of the case. Even if the surface of the battery does not show cracks or any other damage, the cells inside the battery may rupture or catch fire.

⚠ **DANGER! NEVER** use or leave battery packs in areas with temperatures above 60°C. High temperature buildup in the battery, such as could occur near fires or stoves, inside a sun heated car, or in direct sunlight may cause the battery to rupture or catch fire. Excessive temperatures may also degrade battery performance or shorten battery life.

⚠ **DANGER! DO NOT** expose the battery to rain, snow, seawater, or any other liquids. Do not charge or use a wet battery. If the battery gets wet, be sure to wipe it dry before using. The battery is not waterproof.

⚠ **DANGER! NEVER** incinerate used battery packs, since internal battery gas may cause them to rupture, or may cause an explosion.

4 BATTERY CHARGING

■ Caution (for the BP-299 Li-ion BATTERY) (continued)

◇ Battery caution (continued)

⚠ **DANGER! NEVER** solder the battery terminals or NEVER modify the battery pack. This may cause heat generation, and the battery may rupture, emit smoke or catch fire.

⚠ **DANGER!** Use the battery only with the transceiver for which it is specified. Never use a battery with any other equipment, or for any purpose that is not specified in this instruction manual.

⚠ **DANGER!** If fluid from inside the battery gets in your eyes, blindness can result. Rinse your eyes with clean water, without rubbing them, and see a doctor immediately.

⚠ **WARNING!** Immediately stop using the battery if it emits an abnormal odor, heats up, or is discolored or deformed. If any of these conditions occur, contact your Icom dealer or distributor.

⚠ **WARNING! NEVER** use deteriorated battery packs. They could cause a fire.

⚠ **WARNING!** Immediately wash, using clean water, any part of the body that comes into contact with fluid from inside the battery.

⚠ **WARNING! NEVER** put the battery in a microwave oven, high-pressure container, or in an induction heating cooker. This could cause a fire, overheating, or cause the battery to rupture.

CAUTION: Always use the battery within the specified temperature range for the transceiver (-25°C to $+55^{\circ}\text{C}$) and the battery itself (-20°C to $+60^{\circ}\text{C}$). Using the battery out of its specified temperature range will reduce the battery's performance and battery life. Please note that the specified temperature range of the battery may exceed that of the transceiver. In such cases, the transceiver may not work properly because it is out of its operating temperature range.

CAUTION: Shorter battery life could occur if the battery is left fully charged, completely discharged, or in an excessive temperature environment (above +50°C) for an extended period of time. If the battery must be left unused for a long time, it must be detached from the radio after discharging. You may use the battery until the remaining capacity is about half, then keep it safely in a cool dry place within the temperature range as shown below:

- 20°C to +50°C (up to a month)
- 20°C to +35°C (up to three months)
- 20°C to +20°C (up to a year)

4 BATTERY CHARGING

■ Caution (for the BP-299 Li-ion BATTERY) (continued)

◇ Charging caution

⚠ **DANGER! NEVER** charge the battery pack in areas with extremely high temperatures, such as near fires or stoves, inside a sun heated car, or in direct sunlight. In such environments, the safety/protection circuit in the battery will activate, causing the battery to stop charging.

⚠ **WARNING! NEVER** charge the transceiver during a lightning storm. It may result in an electric shock, cause a fire or damage the transceiver. Always disconnect the power adapter before a storm.

⚠ **WARNING! DO NOT** charge or leave the battery in the battery charger beyond the specified time for charging. If the battery is not completely charged by the specified time, stop charging and remove the battery from the battery charger. Continuing to charge the battery beyond the specified time limit may cause a fire, overheating, or the battery may rupture.

⚠ **WARNING!** Occasionally observe the battery pack condition while charging. If any abnormal condition occurs, discontinue using the battery pack.

⚠ **WARNING! NEVER** insert the transceiver (battery attached to the transceiver) into the charger if it is wet or soiled. This could corrode the battery charger terminals or damage the charger. The charger is not waterproof.

CAUTION: DO NOT charge the battery outside of the specified temperature range: BC-240 (10°C to 40°C), BC-214N (15°C to 40°C). Icom recommends charging the battery at 20°C. The battery may heat up or rupture if charged out of the specified temperature range. Additionally, battery performance or battery life may be reduced.

■ Battery chargers

◇ Using the BC-240 to rapid charge the BP-299

The BC-242 provides rapid charging of the BP-299 Li-ion battery pack.

Charging time period for the BP-299: Approximately 4.6 hours
An AC adapter is additionally required.

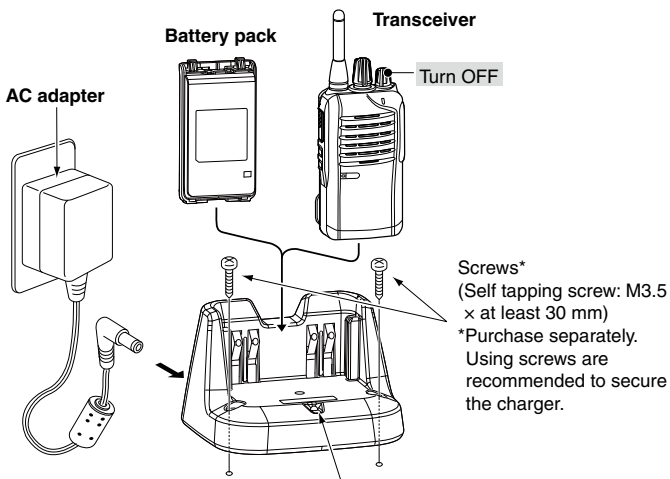

Screws*
(Self tapping screw: M3.5
× at least 30 mm)
*Purchase separately.
Using screws are
recommended to secure
the charger.

Status indicator

- Lights orange: While charging
- Lights green: When charging is completed.
- Blinks red: When a charging error has occurred. Reinstall the battery or the transceiver.

4 BATTERY CHARGING

■ Battery chargers (continued)

◇ **About the BC-240**

Turn the Extend Battery Life function ON or OFF. The battery charger has a function switch on the bottom panel. (Default: OFF)

OFF: The battery is fully charged. The operating time of the transceiver is maximum.

ON: The battery is not fully charged to not shorten the battery life cycle.

The battery life cycle is extended. But the operating time of the transceiver becomes shorter.

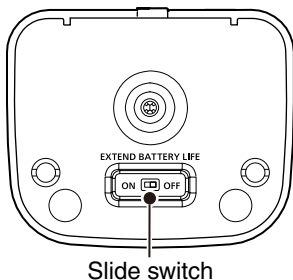

◇ Using the BC-214N to rapid charge the BP-299

You can rapidly and simultaneously charge up to 6 battery packs with the optional BC-214N (the AD-139 CHARGER ADAPTERS are installed.)

Charging time for the BP-299: Approximately 5.0 hours

The following additional item is required:

- An AC adapter (not supplied with some versions) or the OPC-656 DC POWER CABLE

4

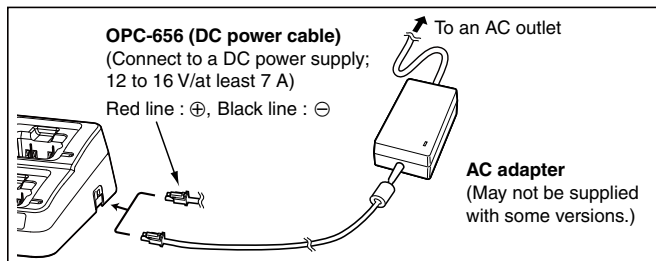
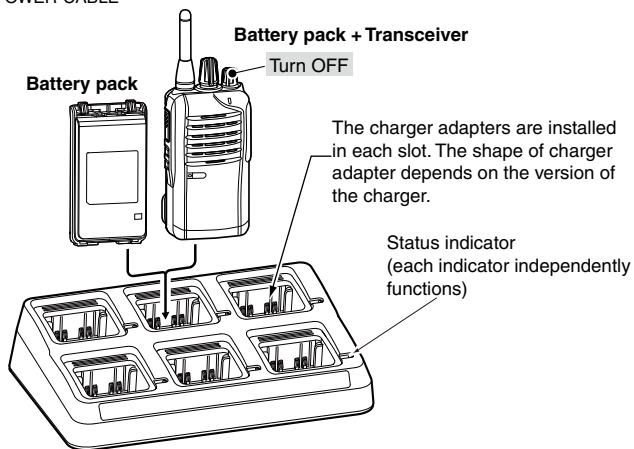

4 BATTERY CHARGING

■ Battery chargers (continued)

/// **IMPORTANT:**

/// Ensure the tabs on the battery pack are correctly aligned with the guide rails inside the charger.

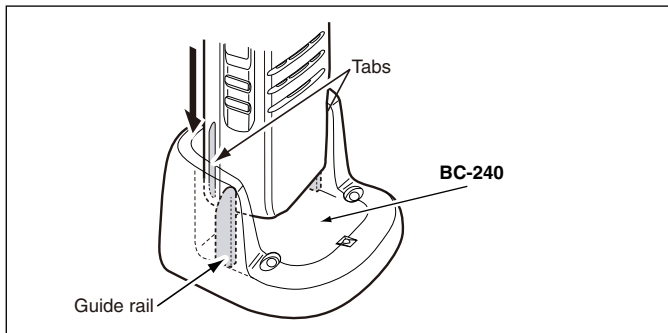

■ Optional BP-263 BATTERY CASE

When using the optional battery case, install 6 × AA (LR6) size alkaline batteries, as illustrated below.

- ① Remove the battery case if it is attached. (p. 3)
- ② Install 6 × AA (LR6) size alkaline batteries, as shown below.
 - Install only alkaline batteries.
 - Be sure to observe the correct polarity.

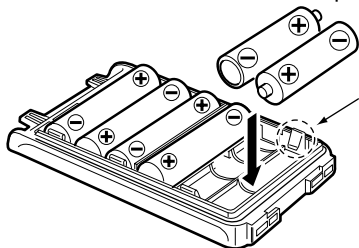

Be careful! The negative terminals of the battery case protrude from the body, so pay attention not to injure your fingers when inserting the batteries.

- ③ Reattach the battery case. (p. 3)

CAUTION:

- When installing batteries, make sure they are all the same brand, type and capacity. Also, do not mix new and old batteries together.
- Keep the battery terminals clean. It's a good idea to regularly clean them.
- Never incinerate used battery cells since internal battery gas may cause them to rupture.
- Never expose a detached battery case to water. If the battery case gets wet, be sure to wipe it dry before using it.
- Never use batteries whose insulated cover is damaged.

NOTE: When the optional battery case is attached, the battery type must be selected as “Battery case operation” when turning the transceiver ON. See page 10 for details.

6 OPTIONS

◇ BATTERY PACK/CASE

Battery pack/case	Voltage	Capacity	Battery life*1
BP-299	7.2 V	3050 mAh	55.9 hrs.
BP-263	Battery case for AA (LR6) × 6 alkaline		—*2

*1 When the power save function is turned ON, and the operating time is calculated under the following conditions;

TX : RX : standby = 5 : 5 : 90

*2 The average operating time depends on the alkaline cells.

◇ CHARGERS

• BC-240 DESKTOP CHARGER + BC-242 AC ADAPTER

For rapid charging of the Li-ion battery pack. An AC adapter may be supplied with the charger, depending on the version.

Charging time period for the BP-299: Approximately 4.6 hours.

• BC-214N MULTI-CHARGER + BC-157S AC ADAPTER

For rapid simultaneously charging of up to six battery packs. An AC adapter may be supplied with the charger, depending on the version.

BC-214N Charger Type	Chargeable Battery	Charging time
With AD-139	BP-299 Li-ion battery	Approx. 5.0 hrs.

◇ DC POWER CABLE

- **OPC-656** DC POWER CABLE

For charging of the battery packs using a 12 V DC power source instead of the BC-157S AC ADAPTER.

◇ BELT CLIP

- **MB-124** BELT CLIP

Exclusive alligator-type belt clip.

6 OPTIONS

◇ OTHER OPTIONS

- **HM-158L/HM-159L** SPEAKER-MICROPHONE

Combination speaker-microphone that provides convenient operation while hanging the transceiver on your belt.

- **HS-94/HS-95/HS-97** HEADSET + **OPC-2004** PLUG ADAPTER CABLE

HS-94 : Ear hook type

HS-95 : Neck-arm type

HS-97 : Throat microphone

OPC-2004 : Allows you to connect the HS-94, HS-95 or HS-97 to the transceiver. After connection, the VOX function can be used.

Approved Icom optional equipment is designed for optimal performance when used with an Icom transceiver.

Icom is not responsible for the destruction or damage to an Icom transceiver in the event the Icom transceiver is used with equipment that is not manufactured or approved by Icom.

Some options may not be available in some countries. Please ask your dealer for details.

■ VOX function

The transceiver has a VOX (voice operated transmission) function, which allows you hands-free operation.

In addition, an HS-94, HS-95 or HS-97 headset and an OPC-2004 plug adapter cable are required.

- The VOX function starts transmission when you speak into the microphone, then automatically returns to receive when you stop speaking without needing to push or release the PTT switch.

6

◇ Optional unit connection

- ① Rotate [VOL] to turn OFF the transceiver power.
- ② Remove the jack cover. (p. 4)
- ③ Connect an optional HS-94, HS-95 or HS-97 headset and OPC-2004, as illustrated below.

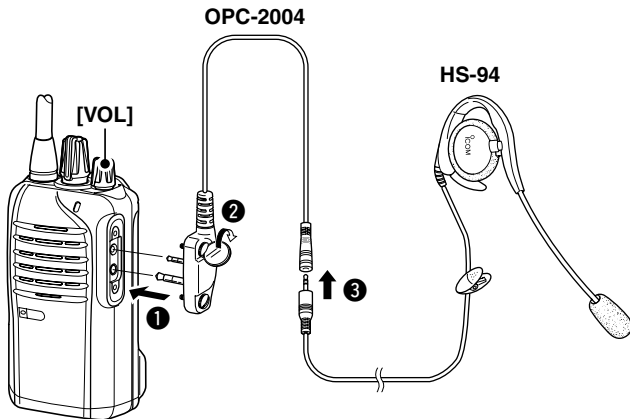

6 OPTIONS

■ VOX function (continued)

◇ Turning the VOX function ON or OFF

The VOX function can be turned ON or OFF when turning the transceiver power ON.

- ① Rotate [VOL] to turn OFF the transceiver power.
- ② Set [ROTARY SELECTOR] to any channel other than Channel 16.
- ③ While holding down [Upper], turn ON the transceiver power to switch the VOX function ON or OFF.
 - 1 beep sounds when the VOX function is turned OFF.
 - 2 beeps sound when the VOX function is turned ON.

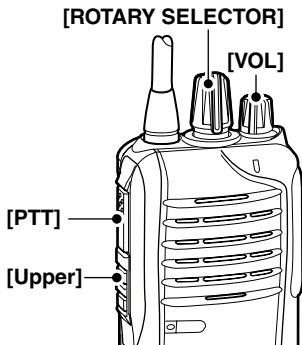

NOTE: This operation may not be available, depending on the preprogramming. Ask your dealer for details.

◇ Setting the VOX gain

The VOX sensitivity level can be adjusted from 1 (minimum) to 10 (maximum). Higher values make the VOX function more sensitive to your voice.

✓ IMPORTANT!

Set the microphone gain before setting the VOX gain. (p. 15)

- ① Connect the optional HS-94, HS-95 or HS-97 headset and the OPC-2004. (p. 30)
- ② Rotate [VOL] to turn OFF the transceiver power.
- ③ Set [ROTARY SELECTOR] to Channel 16.
- ④ While holding down [PTT] and [Upper], rotate [VOL] to turn ON the power and enter the VOX gain adjustment mode.
- ⑤ Push [Upper] to increase, or push [Lower] to decrease the VOX gain while speaking into the optional headset.

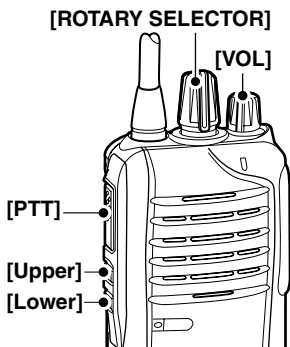

- The adjustable range is 1 (minimum) to 10 (maximum).
 - A beep sounds after pushing [Upper] or [Lower].
If the level is set on 1 or 10, an error beep sounds after pushing.
Therefore, you can determine the current level setting by the type of beep that sounds.
- ⑥ Rotate [VOL] to turn OFF the power, then turn ON again to exit the VOX gain adjustment mode.

/// **NOTE:** This operation may not be available, depending on the preprogramming. Ask your dealer for details.

7 SPECIFICATIONS

◇ General

- Frequency coverage: 446.00625–446.09375 MHz
- Mode: 8K50F3E (FM)
- Current drain (at 7.2 V): TX 400 mA approx.
RX Max. audio 330 mA approx.
- Power supply requirement: 7.2 V DC nominal* (negative ground)
*Only specified Icom's battery pack
- Frequency stability: ± 2.5 ppm (-25°C to $+55^{\circ}\text{C}$)
- Antenna impedance: $50\ \Omega$ nominal
- Weight: Approximately 290 g (with BP-299)

◇ Dimensions

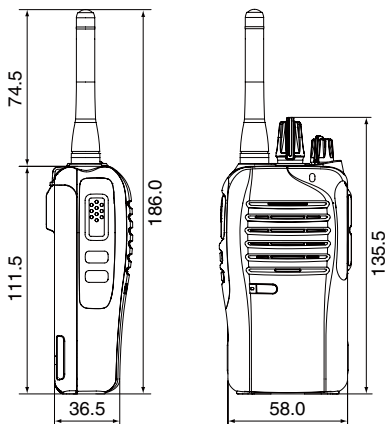

Unit: mm

◇ Transmitter

- Output power: 0.5 W ERP
- SAR 10g: Estimation 0.5 W/kg
- Modulation system: Variable reactance frequency modulation
- Max. frequency deviation: ± 2.5 kHz
- Spurious emissions: 0.25 μ W (1 GHz or below)
1.00 μ W (above 1 GHz)
- Adjacent channel power: 60 dB
- External mic. connector: 3 conductor 2.5 (d) mm/2.2 k Ω

◇ Receiver

- Receive system: Double conversion superheterodyne
- Sensitivity (20 dB SINAD): 26.5 dB μ V/m
- Squelch sensitivity: 26.5 dB μ V/m (Threshold)
- Intermodulation rejection ratio: 86.29 dB μ V/m
- Spurious response rejection ratio: 91.29 dB μ V/m
- Adjacent channel selectivity: 81.29 dB μ V/m
- Audio output power: 0.8 W (typical) at 5% distortion with a 12 Ω load
0.4 W (typical) at 5% distortion with an 8 Ω load
- External speaker connector: 2 conductor 3.5 (d) mm/8 Ω

All stated specifications are subject to change without notice or obligation.

INDEX

A		K	
ABOUT CE AND DOC.....	ii	Key functions	7
Auto scan function	11, 17	Lock key	8
B		Memory channel	
Battery		select keys.....	7
Case	3, 26	Monitor key	8
Caution (Li-ion).....	18	Priority channel	
Chargers.....	22	rewrite keys	7
Life.....	27	Priority channel	
Pack.....	3	select keys.....	7
Type selection.....	10	Scan keys	7
Belt clip	2	Siren key.....	8
C		Surveillance key	8
Channel selection.....	11	L	
CTCSS tone	12	LED indicator	6, 9
D		Lower key [Lower].....	6
Definitions.....	i	M	
DISPOSAL.....	ii	Microphone gain setting	15
DTCS code	12	O	
F		Optional unit connection	30
Front panel.....	5	Options	27
J		P	
Jack cover.....	4, 6	Penalty timer.....	14
		Power ON	10
		Power save function.....	17
		Preprogrammed frequency and	
		CTCSS tone list (Default)	13
		Priority A channel selection	17
		PTT Switch [PTT]	6

R

Rapid charge	
Using the BC-214	
to charge the BP-299	22
Using the BC-240	
to charge the BP-299	24
Receiving	12
Rotary selector	5

S

Side panel	5
Speaker-microphone jack	
[SP MIC]	6
Specifications	33
Squelch level setting	16
Supplied accessories	1

T

Time-out timer	14
Top panel	5
Transmitting	12
Inhibit function	14
Notes	14

U

Upper key [Upper]	6
-------------------------	---

V

Volume control [VOL]	5
VOX function	30
Turning ON or OFF	31
Unit connection	30
VOX gain setting	32

MEMO

.....

.....

.....

.....

.....

.....

.....

.....

.....

.....

.....

.....

Count on us!

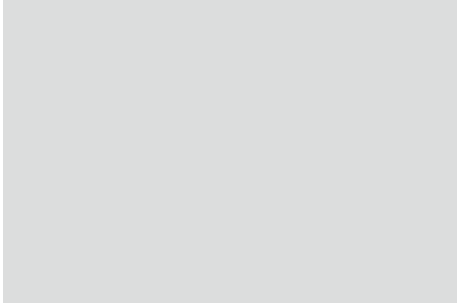

A6954D-1EU-2
Printed in Japan
© 2011– 2021 Icom Inc.
Jun. 2021

Icom Inc.

1-1-32 Kamiminami, Hirano-ku, Osaka 547-0003, Japan