

# FURUNO

## FISH FINDER

Model **FCV-1900**

*See underwater **clearly and accurately**  
with incredible high definition echoes*



Photo: 19" Marine Display MU-190HD  
(Optional supply)



[www.furuno.com](http://www.furuno.com)



# FISH FINDER

Model

# FCV-1900

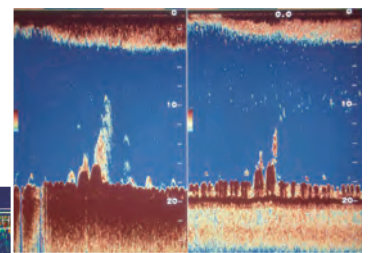

Photo: 19" Marine Display MU-190HD  
(Marine Display and Hanger are optional supply)

## Increased transmission rate for more details

With a transmission rate that has been increased by up to 1.4 times (at 200 m range), FCV-1900 ensures excellent target separation and clarity.

Same scene captured with previous model



### Individual fish

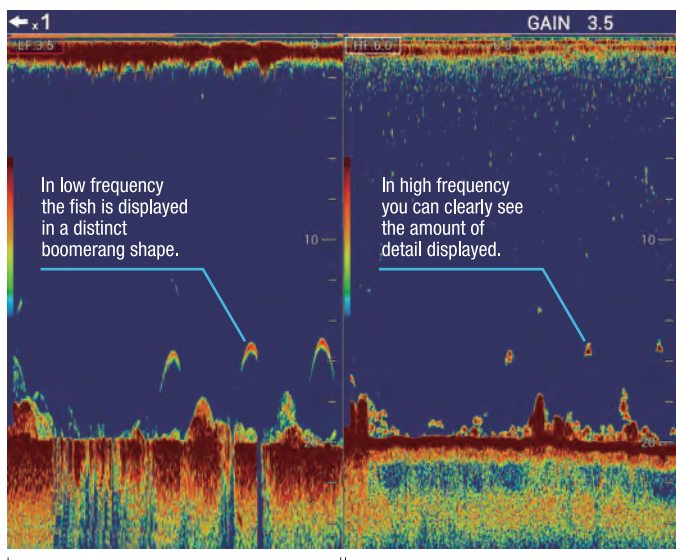

Low Frequency

High Frequency

### Artificial reefs

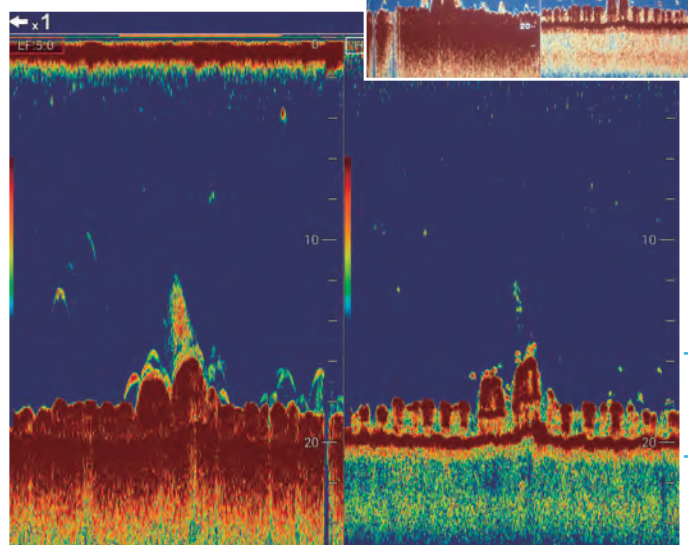

See artificial reefs in greater detail

▶ You can find more information and media by searching for FCV-1900 on [FURUNO.com](http://FURUNO.com)

FCV-1900



# Functions for improved efficiency

## Display up to four different frequencies

Display up to four different frequencies together in a compact and easy way by connecting a required network fish finder. Since there is no need to install additional displays, this system is especially useful for small vessels.

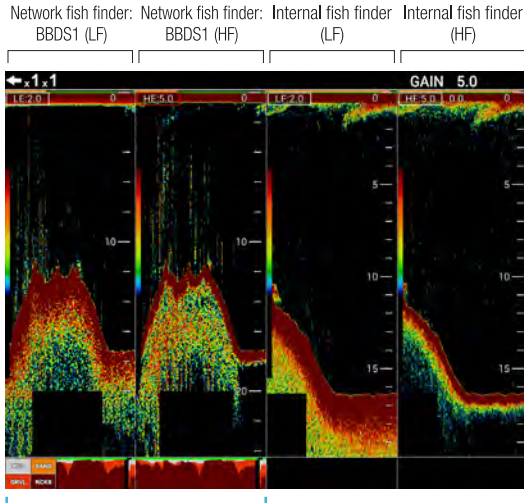

### Connect a BBDS1 network fish finder for bottom discrimination function

The bottom discrimination function indicates whether the bottom is composed mainly of rocks, gravel, sand or mud. This information aids in identifying fish species, which can increase efficiency.



## Scroll back function

With the press of a button you can activate the scroll back function to instantly review past echoes. Up to two previous screens can be viewed.

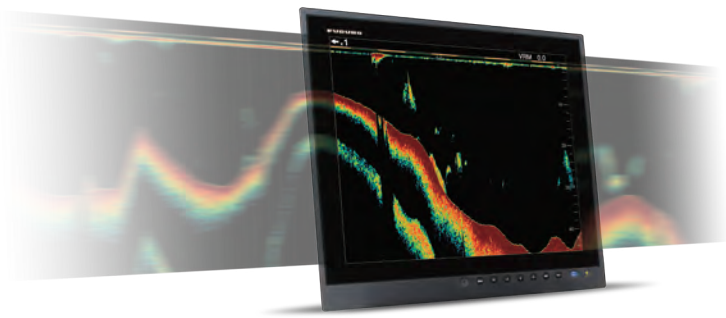

## Capture and review videos and screenshots\*

Now you can capture screenshots and video when dropping your net or when searching for fish. Captured screenshots and video display position\* and time of capture, for simple review. Improve your fishing by comparing fish finder echoes with your resulting catches.

\*GPS input required. \*Feature coming soon.



## Simultaneous gain setting for increased visibility

Display two different gain settings simultaneously for increased visibility in changing water conditions and when changing vessel speed.

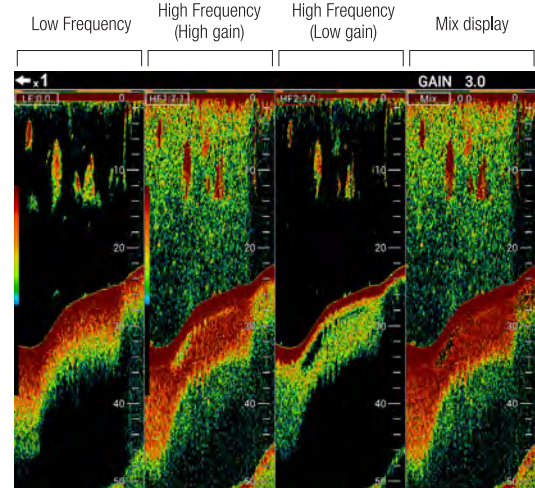

## FURUNO Free Synthesizer transceiver for adjustable operating frequency

Retrofitting is made easy. With FFS technology, you can easily replace an FCV-1200L processor unit while utilizing the same transducer for convenient installation.

## Improved control unit for simple and intuitive operation

The control unit features a water resistant touch pad that works even when wearing rubber gloves. You can use the touch pad for setting up VRM and TLL in an instant.

## Zero Line Rejection

Observe clear echoes from just 3 meters below your vessel with Zero Line Rejection, allowing you to better analyze the water column from near to far.

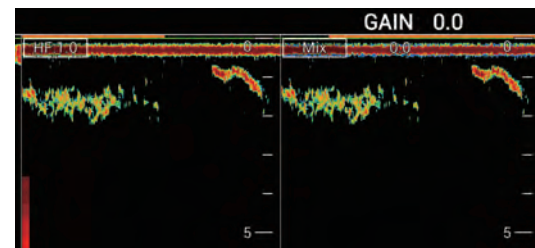

## Upgrade to FCV-1900B Hi-Res Fish Finder or FCV-1900G Fish size indicator

By purchasing and installing a software license, you can upgrade your FCV-1900 model to a FCV-1900B Hi-Res Fish Finder\* or a FCV-1900G Fish Size Indicator\*, both utilizing the latest TruEcho CHIRP™ technology. FCV-1900G offers a precise fish size histogram for accurate estimation of fish size and density of schools of fish. With fish size histogram, targets can be properly evaluated, spelling increased efficiency and profitability. For further details, please contact your local FURUNO national distributor.

\*TruEcho CHIRP™ compatible transducer required.

## SPECIFICATIONS

### 1. GENERAL

- 1.1 **Transmitting frequency** 15 kHz to 200 kHz, Free-synthesize  
 1.2 **Output power** 1, 2 or 3 kW rms  
 1.3 **Transmitting rate** 10 to 2700 pulse/min  
 (5 to 3000 m range, normal mode)  
 1.4 **Transmitting mode** Standard mode only  
 1.5 **Pulse length** 0.05 to 5 ms  
 1.6 **External monitor (required specifications)**  
**Display resolution** XGA (1024x768), SXGA (1280x1024),  
 FHD(1920x1080)  
 SXGA (1024x1280)

### 2. PROCESSOR UNIT

- 2.1 **Color indication**  
**Echo color** 8, 16 or 64 colors according to echo intensity  
**Back color** Select from 5 colors  
 2.2 **Hue** 7 steps (standard, Hue 1 to 5, customized)  
 2.3 **Echo display mode** Single mode (high/low frequency), Dual-frequency,  
 Zoom, User 1/2  
 User 1/2 available to use mixture, multi-gain,  
 telesounder and external sounder display  
 2.4 **Zoom display** Bottom-lock expansion, Bottom zoom,  
 Marker zoom, Discrimination zoom  
 2.5 **Depth range** 5 to 3000 m  
 2.6 **Range shift** 2000 m max.  
 2.7 **Expansion range** 2 to 200 m  
 2.8 **Display advanced speed** 6 steps (Lines/TX: Freeze, 1/4, 1/2, 1/1, 2/1, 4/1)  
 2.9 **Data recording** Echo display and measured data can be recorded in  
 internal memory  
 2.10 **Language** Chinese, Danish, English, French, Japanese, Korean,  
 Russian, Spanish, Norwegian

### 3. INTERFACE

- 3.1 **Number of port**  
**NMEA** 3 ports, NMEA V1.5/2.0/3.0  
**LAN** 1 port, Ethernet 100Base-TX (HUB required)  
**CIF** 1 port  
**Net sonde** 1 port, (sonde marker/ sonde KP)  
**Video signal** 1 port, HDMI type-D  
**External KP** 1 port  
**Temperature sensor** 1 port  
**USB** 1 port, USB2.0  
 (specified monitor brilliance control available)

### 3.2 Data sentences

**Input** GGA, GLL, GNS, MTW, VHW, VTG, ZDA

**Output** DBS, DBT, DPT, MTW, TLL

### 3.3 Output proprietary sentences

**PFEC** SDbcd, SDfkg, SDmrk, pidat

### 4. POWER SUPPLY

- 4.1 **Processor unit** 12-24 VDC: 8.3-3.9 A  
**Rectifier (RU-1746B-2, option)** 100/110/115/220/230 VAC, 1 phase, 50/60 Hz  
**AC/DC power supply unit (PR-240, option)** 100-115/200-230 VAC, 1 phase, 50-60 Hz

### 5. ENVIRONMENTAL CONDITIONS

- 5.1 **Ambient temperature** -15°C to +55°C  
 5.2 **Relative humidity** 95% or less at +40°C  
 5.3 **Degree of protection** IP22  
 5.4 **Vibration** IEC 60945 Ed.4

## EQUIPMENT LIST

#### Standard

1. Processor Unit (FCV-1901) ..... x1  
 2. Control Unit (FCV-1902) ..... x1  
 3. Spare parts, Installation materials

#### Option

Transducer, Thru-hull pipe, Interface Unit (FCV-1903), Ethernet HUB,  
 Junction box, Booster box, Temperature sensor,  
 AC/DC power supply unit, Rectifier, Installation material,  
 Cable assembly, Cable (for transducer extension)

## Processor Unit

**FCV-1901**  
 10.2 kg 22.5 lb

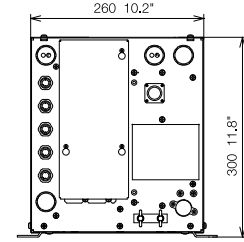
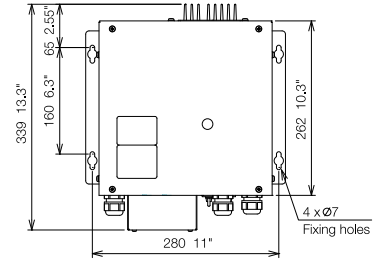

## Control Unit

**FCV-1902**  
 1.1 kg 2.4 lb

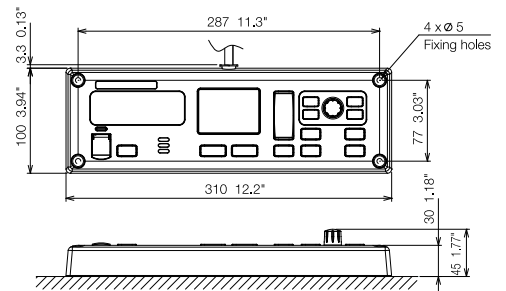

## Interconnection Diagram

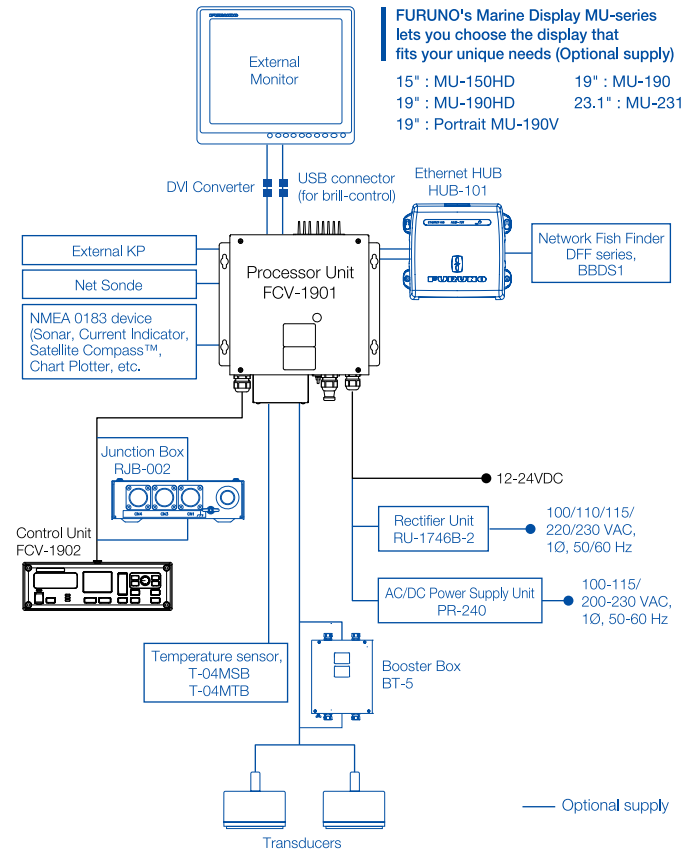

Beware of similar products

All brand and product names are registered trademarks, trademarks or service marks of their respective holders.

SPECIFICATIONS SUBJECT TO CHANGE WITHOUT NOTICE

**FURUNO ELECTRIC CO., LTD.**  
 Japan | www.furuno.com

**FURUNO U.S.A., INC.**  
 U.S.A. | www.furunousa.com

**FURUNO PANAMA S.A.**  
 Republic of Panama | www.furuno.com.pa

**FURUNO (UK) LIMITED**  
 U.K. | www.furuno.co.uk

**FURUNO NORGE A/S**  
 Norway | www.furuno.no

**FURUNO DANMARK A/S**  
 Denmark | www.furuno.dk

**FURUNO SVERIGE AB**  
 Sweden | www.furuno.se

**FURUNO FINLAND OY**  
 Finland | www.furuno.fi

**FURUNO POLSKA Sp. Z o.o.**  
 Poland | www.furuno.pl

**FURUNO DEUTSCHLAND GmbH**  
 Germany | www.furuno.de

**FURUNO FRANCE S.A.S.**  
 France | www.furuno.fr

**FURUNO ESPAÑA S.A.**  
 Spain | www.furuno.es

**FURUNO ITALIA S.R.L.**  
 Italy | www.furuno.it

**FURUNO HELLAS S.A.**  
 Greece | www.furuno.gr

**FURUNO (CYPRUS) LTD**  
 Cyprus | www.furuno.com.cy

**FURUNO EURUS LLC**  
 Russian Federation | www.furuno.ru

**FURUNO SHANGHAI CO., LTD.**  
 China | www.furuno.com/cn

**FURUNO CHINA CO., LTD.**  
 Hong Kong | www.furuno.com/cn

**FURUNO SINGAPORE**  
 Singapore | www.furuno.sg

**PT FURUNO ELECTRIC INDONESIA**  
 Indonesia | www.furuno.id